

## **Application Note**

8VSB DTV Modulator/Translator  
Model Number: Xtreme-1000E



## **Introduction**

This application note describes the XTREME-1000E 8VSB Digital Translator and its applications.

## **Product Description**

The XTREME-1000E is used for reception of an 8-VSB RF signal and demodulation into baseband signals, updates the PSIP VCT's Station ID, Major and Minor Channel Numbers, and remodulates the baseband signal into an 8-VSB RF signal.

The main features of the XTREME-1000E are:

- ❑ 8VSB Off-Air input, 8VSB demodulation to base-band Transport Stream
- ❑ Agile RF Input channel frequency (VHF & UHF CH2~69)
- ❑ Automatic/Fixed (user selectable) Adaptive linear and non-linear Pre-correction without external equipment
- ❑ RF Output, Agile Frequency on both UHF and VHF Band, or fixed frequency (TX channel number must be specified upon order)
- ❑ Inputs for SMPTE-310M, DVB-ASI, and ATSC RF input (CH2~CH69)
- ❑ MPEG2 Transport Stream SMPTE-310M output from ATSC RF Input
- ❑ Digital AGC/MGC
- ❑ External 10MHz Reference input
- ❑ Fine Pilot Frequency Adjust
- ❑ Firmware Upgradeable through RS232
- ❑ Loss of RF signal Alarm, Loss of Transport Stream Alarm, Loss of PLL Lock Alarm
- ❑ Correction Settings stored on Flash Memory and called upon Power Up
- ❑ PSIP Modification (Optional)
- ❑ Complies with ATSC A53 specification for 8-VSB modulation for terrestrial broadcast of a high definition digital TV signal
- ❑ 2U Rack Mountable



21540 Prairie St., Unit B - Chatsworth, CA 91311  
Phone (818) 773-0333 Fax (818) 773-8330

[www.ktechtelecom.com](http://www.ktechtelecom.com)

## 1. Functional Block Diagram

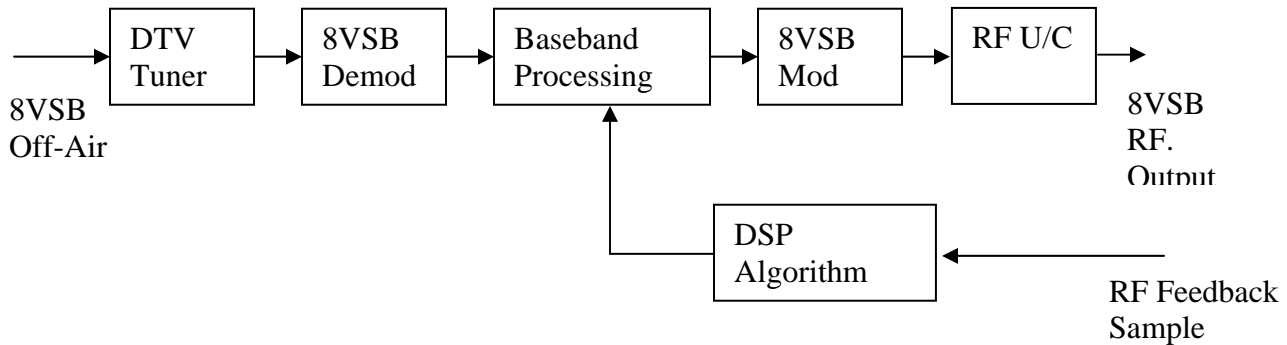

Figure 1-1: Functional Block Diagram of the XTREME-1000E

### DTV Tuner

The DTV Tuner accepts an 8-VSB RF off-the-air signal (CH2~CH69) and down converts it to a 44.0 MHz IF signal. The DTV Tuner accepts 8-VSB RF signal inputs for a user selectable via HyperTerminal on any of the VHF/UHF channels #2-69.

### 8-VSB Demodulator

The 8-VSB Demodulator demodulates the 44.0 MHz I.F. signal into a baseband signal, i.e. MPEG2. It's equalizer and Reed Solomon decoding techniques, help correct channel multipath errors. It also performs digital matched filtering to optimize performance over noise. This unit is implemented with LG 5<sup>th</sup> Generation 8VSB demodulation chip.

### Baseband Processing

The baseband processing includes the PSIP VCT Update, Null Packet Insertion and PCR Correction. The first step in baseband processing involves updating the PSIP. The PSIP Virtual Channel Table's (VCT) Station ID, Major Channel and Minor Channel Numbers are updated. The next step in the process is Null Packet Insertion. The Null Packet Insertion does the following:

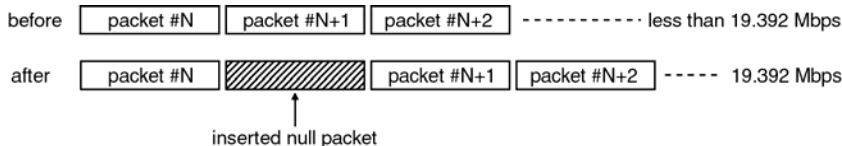

Figure 1-2: Null Packet Insertion

If the MPEG2 Transport Stream is less than 19.392 Mbps, null packets are inserted into the MPEG2 Transport Stream to bring the rate up to 19.392 Mbps. The final step is PCR Correction. The Program Clock Reference (PCR), embedded within the transport stream, is used to synchronize a receiver's clock with an encoder's clock. The original PCR values that were stamped into the stream by the original encoder will not be the correct PCR values for the receiver after null packets are inserted into the stream. The PCR values need to be re-stamped so that the receiver will have the correct PCR values, thus avoiding PCR clock jitter at the receiver end.

The Baseband Processing also performs TS input processing for SMPTE-310M or DVB-ASI inputs, and converts the TS signal into parallel format suitable for the 8VSB Modulator.

In addition, the 8VSB input signal is converted into SMPTE-310M TS signal as an output.



21540 Prairie St., Unit B - Chatsworth, CA 91311

Phone (818) 773-0333 Fax (818) 773-8330

[www.ktechtelecom.com](http://www.ktechtelecom.com)

**RF Upconverter**

Three kinds of upconverters are available, Agile – UHF upconverter, Agile – VHF upconverter and fixed upconverter. The Upconverter takes the 44.0 MHz IF transmit signal and converts it up to a higher frequency. The RF upconverter places the 8VSB I.F. onto any of the user specified VHF/UHF channel. This channel number is selectable by user using the HyperTerminal command and tunes to any channels in the UHF band (Agile – UHF upconverter) or VHF band (Agile – VHF upconverter). The fixed channel upconverter only outputs one fixed channel specified by user upon ordering.

**RF Feedback Sample/DSP Algorithm**

The RF Feedback sample is used to measure linear and non-linear distortions. The DSP algorithm adjusts its internal FIR taps to maximize the output SNR values. The Baseband processing also includes DSP electronics to measure feedback signal and generation of self-contained automatic linear and non-linear correction. The linear and nonlinear pre-correction can be set for automatic mode or fixed mode upon user selection. The transmit power Software Automatic Gain Control (AGC) and Manual Gain Control (MGC) is available upon user selection from the front panel menu. The transmit power Hardware AGC is available upon user selection from HyperTerminal.

**2. Front and Back Panel**

The front panel of the XTREME-1000E is shown below in Figure 2-1.

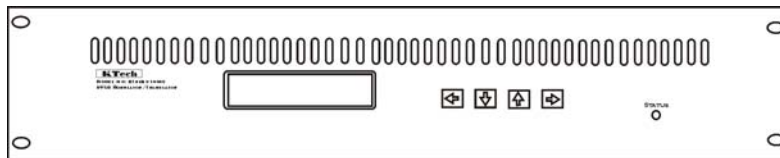

Figure 2-1: Front Panel of the XTREME-1000E

The back panel of the XTREME-1000E is shown below in Figure 2-2.

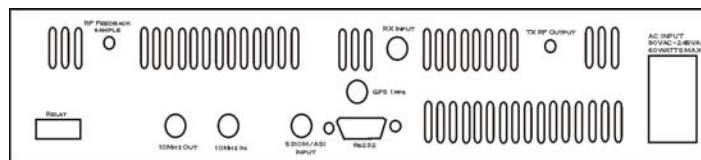

Figure 2-2: Back Panel of the XTREME-1000E



21540 Prairie St., Unit B - Chatsworth, CA 91311

Phone (818) 773-0333 Fax (818) 773-8330

[www.ktechtelecom.com](http://www.ktechtelecom.com)

### 3. I/O Connector Description

<b>Signal</b>	<b>Connector</b>	<b>Description</b>
SMPTE-310M/ASI INPUT	BNC	MPEG2 Transport Stream Input. SMPTE-310M is limited to precisely at 19.39MBPS. ASI input is limited to data rate less than 19.39MBPS. User selectable between 310M and ASI input.
SMPTE-310M OUTPUT	BNC	SMPTE-310M MPEG2 Transport Stream Output. This signal is generated from the RF input tuner with the channel number selected by user via HyperTerminal.
RF INPUT	BNC	Input for Off-the-Air 8VSB reception.
RF FEEDBACK SAMPLE	SMA	Input for RF feedback sample to be used for linear and non-linear pre-correction. The power level should be 0dBm +/- 1dB
TX RF OUTPUT	SMA	RF output for 8VSB Modulator, 0dBm output
10MHZ Output	BNC	10MHz Internal Reference output. This is typically looped back into 10MHZ Input
10MHZ INPUT	BNC	10MHz Reference Input. All internal clocks for symbol clock, pilot tone, and carrier frequency is generated with PLL to this 10MHZ Input.
RS232	DSUB 9 Socket	General-purpose communications port. This port used to update the firmware, monitor health and status
Alarm	3 terminal Phoenix	Normally closed/opened contact closure. Activated upon PLL unlock, MPEG2 Loss, Tuner RF Signal Loss, Demod SNR Threshold, AC Power Loss



21540 Prairie St., Unit B - Chatsworth, CA 91311

Phone (818) 773-0333 Fax (818) 773-8330

[www.ktechtelecom.com](http://www.ktechtelecom.com)

## 4. Applications

The XTREME-1000E is designed to be used as a part of an 8VSB Digital Translator. In this configuration, Ktech provides the Translator and customer provides the rest of the components such as a Power Amplifier and an output Transmit Band-Pass Filter (BPF). Typically, the BPF is an 8<sup>th</sup>-order FCC Mask Filter.

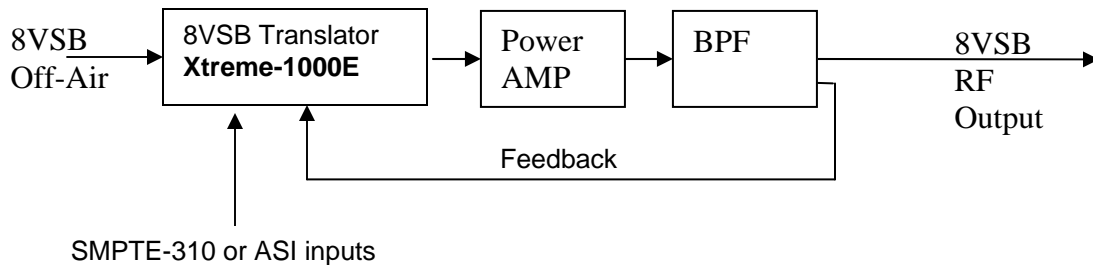

Figure 4: Application of the XTREME-1000E for 8VSB Digital Translator

The unit is also capable of accepting SMPTE-310M and ASI input signals upon HyperTerminal command selection. Using the unit's proprietary Phase Noise correction capability, the unit is able to isolate its transmit phase noise from the received carrier. This allows translators implemented with XTREME-1000 to be hopped as many times as desired and not add carrier phase noise every time the system is repeated.

The unit also uses the RF feedback sample to control its output power level to within +/-5% of the total output power. This is performed by a digital AGC and temperature compensated to hold the output power upon its operating temperature range. User also has a front panel manual setting option to increase or decrease the transmitted output power.

The linear pre-correction measures the linear distortion present at the output of the translator and pre-correct its modulator output such that the output linear distortion is minimized. Upon detection of performance degradation due to linear distortion, the unit self-corrects such linear distortions. Linear distortions are created typically due to change in temperature and change in output filter response and cause SNR, MER, Group delay, and Magnitude response degradation.

The non-linear pre-correction measures the non-linear distortion present at the output of the translator and pre-correct its modulator output such that the output non-linear distortion is minimized. Upon detection of performance degradation due to non-linear distortion, the unit self-corrects such non-linear distortions. Non-linear distortions are created typically due to change in temperature and change in amplifier's transistor response over time and cause increase IMD levels. Such increased IMD levels may violate the FCC mask or create adjacent channel interference.

**Ktechtelecom**

21540 Prairie St., Unit B - Chatsworth, CA 91311

Phone (818) 773-0333 Fax (818) 773-8330

[www.ktechtelecom.com](http://www.ktechtelecom.com)

## 5. User Menu Description

The XTREME-1000E front panel menus include:

- Input Menu
- Setting Menus
- Status Menus
- PSIP Menu (Optional)

The menus can be scrolled through with the **LEFT/RIGHT** keys. The menu settings can be changed via the **UP/DOWN** keys.

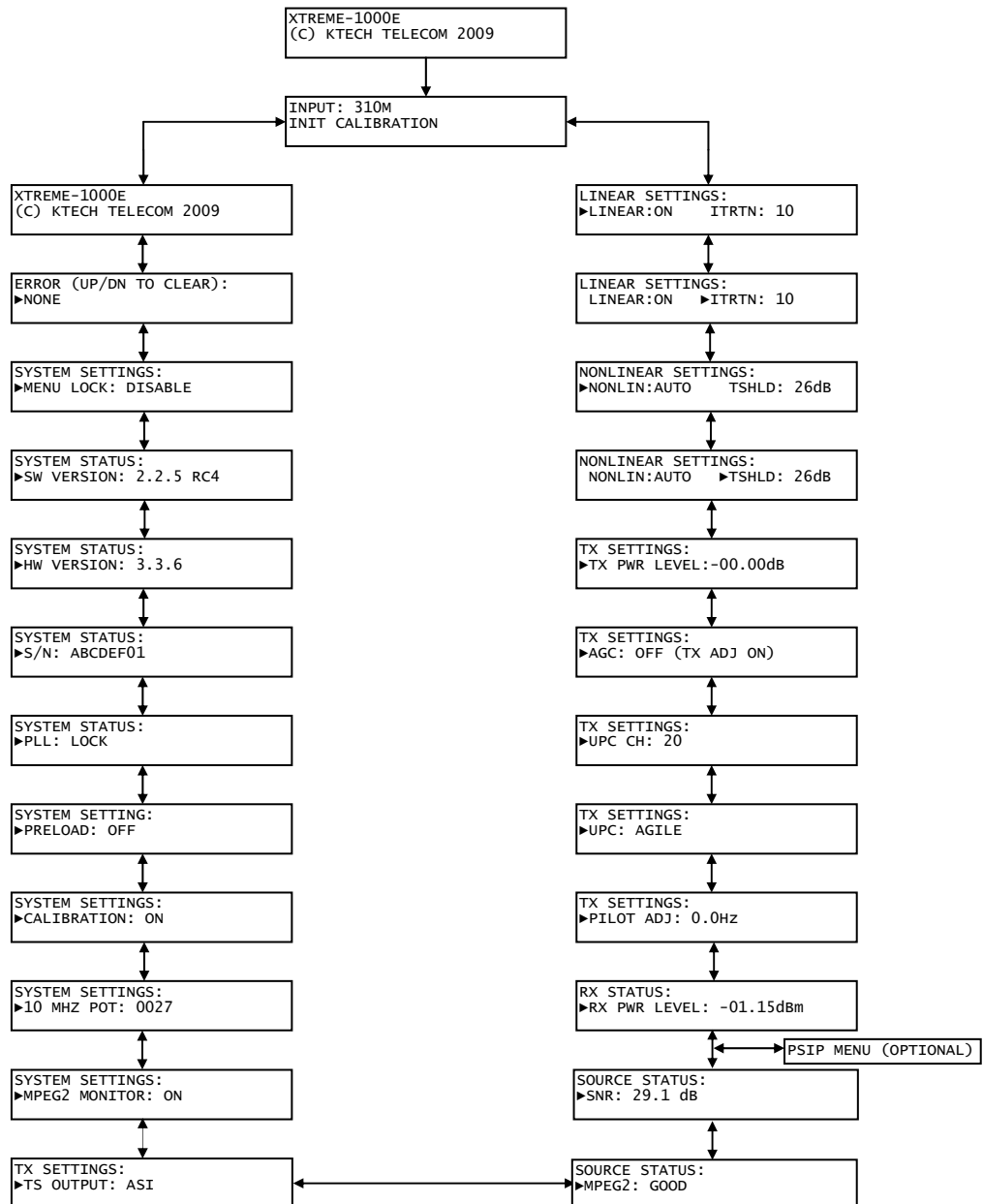

If PSIP option is purchased, the PSIP menu will be activated.

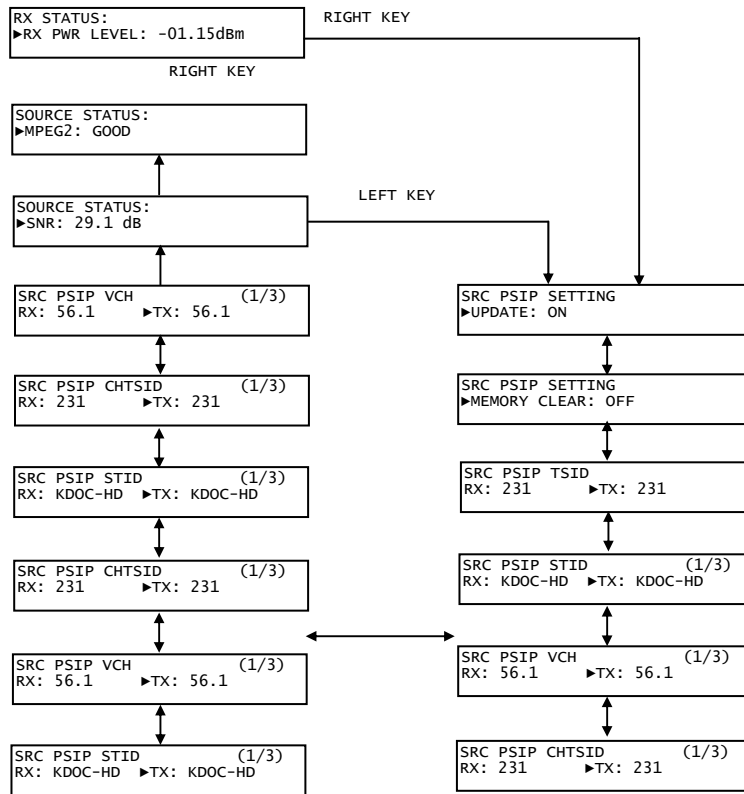

21540 Prairie St., Unit B - Chatsworth, CA 91311

Phone (818) 773-0333 Fax (818) 773-8330

[www.ktechtelecom.com](http://www.ktechtelecom.com)

## 5.1 Input Menu

The Input Menu include:

- Input source menu
- Current status

<p>INPUT : ASI SNR : 36.12dB</p>
--------------------------------------

This menu displays the input source. It also displays the status information such as feedback SNR, feedback IMB, status of modulator, and precorrection settings.

A summary and description of the six tuning modes is shown in the table below. The menu options will depend on which I/O cards have been installed.

Input	Description
02-69	8-VSB Input
ASI	ASI Input
310M	SMPTE-310M Input

The feedback SNR is only displayed after the unit is finished with calibration, linear precorrection and nonlinear precorrection processes.

The bottom line of the VFD displays the status of the modulator.

Status	Description
BOOTING UP...	Unit is booting up and performing system checks
INIT CALIBRATION	Initializing calibration
-CALIBRATING...	Performing calibration of internal system
INIT LINEAR PCORR	Initializing linear precorrection
-LINEAR [A] ...	Performing class A linear precorrection
-LINEAR [AB] ...	Performing class AB linear precorrection
UPDATE LINEAR	Updating the linear filter with new settings
INIT NONLIN PCORR	Initializing nonlinear precorrection
-NONLINEAR [A] ...	Performing class A nonlinear precorrection
-NONLINEAR [AB] ...	Performing class AB nonlinear precorrection
UPDATING NONLINEAR	Updating the nonlinear filter with new settings
LINEAR: ON	Current setting of linear precorrection: ON – linear precorrection is on AUTO – linear precorrection is in auto mode OFF – linear precorrection is off
NONLIN: ON	Current setting of nonlinear precorrection: ON – nonlinear precorrection is on AUTO – nonlinear precorrection is in auto mode OFF – nonlinear precorrection is off



21540 Prairie St., Unit B - Chatsworth, CA 91311

Phone (818) 773-0333 Fax (818) 773-8330

[www.ktechtelecom.com](http://www.ktechtelecom.com)



## 5.2 Setting Menus

The Setting menus include:

- Linear Mode
- Linear Threshold
- Nonlinear Mode
- Nonlinear Threshold
- TX Power Level
- TX AGC
- TX Upconverter Channel
- TX Upconverter Type
- TX Pilot Adjustment
- TS Output
- MPEG-2 Monitor
- 10 MHz Potentiometer
- Calibration
- Preload
- Menu Lock

### 5.2.1 Linear Mode

LINEAR SETTINGS:  
▶LINEAR:ON

This menu configures the XTREME-1000E to select the linear process in three different modes.

Linear Mode	Description
ON	This mode will run linear equalizer ITRTN times after all initial precorrection is finished and is only measuring feedback snr and IMD.
OFF	This mode will turn off the linear equalizer.
AUTO	This mode will use the last calculated values for the linear equalizer. However, if the feedback SNR is below the linear threshold, it will perform the linear process again and update the linear equalizer.
HOLD	This mode will use last calculated values for the equalizer.

### 5.2.2 Linear Threshold

LINEAR SETTINGS:  
LINEAR:AUTO

This menu configures the XTREME-1000E to set the linear SNR threshold.

Linear Threshold	Description
20-40	The feedback SNR threshold that the linear equalizer needs to meet during the linear process. In AUTO mode, this is the threshold for restarting the linear process.



21540 Prairie St., Unit B - Chatsworth, CA 91311

Phone (818) 773-0333 Fax (818) 773-8330

[www.ktechtelecom.com](http://www.ktechtelecom.com)

### 5.2.3 Nonlinear Mode

NONLINEAR SETTINGS:  
▶NONLIN:ON

This menu configures the XTREME-1000E to select the nonlinear process in three different modes.

Nonlinear Mode	Description
ON	This mode will use the last calculated values for the nonlinear precorrection process.
OFF	This mode will turn off the nonlinear precorrection process.
AUTO	This mode will use the last calculated values for the nonlinear precorrection. However, if the feedback SNR is below the nonlinear threshold, it will perform the nonlinear process again.

### 5.2.4 Nonlinear Threshold

NONLINEAR SETTINGS:  
NONLIN:ON

This menu configures the XTREME-1000E to set the nonlinear SNR threshold.

Nonlinear Threshold	Description
30-60	The feedback shoulder level needs to be met. In AUTO mode, this is the threshold for restarting the nonlinear process.

### 5.2.5 TX Power Level

TX SETTINGS:  
▶TX PWR LEVEL:-

This menu configures the XTREME-1000E to set the RF output power. This can only be adjusted when the TX AGC is turned off.

TX power level	Description
-43.64dB to +4.48dB	This sets the output RF power level.

### 5.2.6 TX AGC

TX SETTINGS:  
▶AGC:OFF (TX ADJ ON)

This menu configures the XTREME-1000E to set the TX AGC. When the AGC is turned on, it will first measure the feedback power and use it as the reference. Then it will adjust the TX PWR LEVEL automatically to ensure the feedback power is the same as the reference. HW AGC can only be enabled by HyperTerminal command.



AGC	Description
ON (HW)	Turns on the TX AGC controlled by hardware. The number in (HW – 92) indicates the TX power detected. Minimum number is 0. Maximum number is 255.
OFF (TX ADJ OFF)	Turns off the TX AGC, but output power will decrease by 2dB if no feedback is detected. TX power is not adjustable.
OFF (TX ADJ ON)	Turns off the TX AGC and output power level always remain constant with or without feedback. TX power is adjustable.
ON (SW)	Turns on the TX AGC controlled by software.

### **5.2.7 TX Upconverter Channel**

```
TX SETTINGS:
▶UPC CH:20
```

This menu displays the TX upconverter channel. The upconverter channel is set by HyperTerminal command. Make sure the TX upconverter channel is the same channel that is built into the unit.

Upconverter Channel	Description
2-69	Set the TX upconverter channel

### **5.2.8 TX Upconverter Type**

```
TX SETTINGS:
▶UPC: AGILE
```

This menu displays the upconverter type. The upconverter type is set by HyperTerminal command. Option AGILE is for multiple frequency upconverter. Option FIXED is for fixed frequency upconverter.

UPC	Description
AGILE	Multiple frequency upconverter
FIXED	Fixed frequency upconverter

### **5.2.9 TX Pilot Adjustment**

```
TX SETTINGS:
▶PILOT ADJ:
```

This menu configures the XTREME-1000E to offset the pilot frequency. It has a range of +/- 10KHz with a 0.5 Hz resolution.

Amplifier Class	Description
-35000 – 35000 Hz	Pilot frequency offset



### 5.2.10 TS Output

TX SETTING:  
▶TS Output: ASI

This menu configures the XTREME-1000E to set transport stream output type. It has two types of output: ASI and SMPTE.

### 5.2.11 MPEG2 Monitor

SYSTEM SETTING:  
▶MPEG2 MONITOR: ON

This menu configures the XTREME-1000E to set MPEG-2 monitor in the software.

MPEG2 MONITOR	Description
ON	Turns on MPEG-2 monitor
OFF	Turns off MPEG-2 monitor

### 5.2.12 10 MHz Potentiometer

SYSTEM SETTING:  
▶10 MHZ POT:0027

This menu configures the XTREME-1000E to set the 10 MHz digital potentiometer setting. It adjusts the 10 MHz clock with higher precision based on the setting. Also, it will adjust the pilot frequency of the spectrum if using a looped thru 10MHz clock input output.

10 MHz Potentiometer	Description
0 - 1023	Set the digital potentiometer

### 5.2.13 Calibration

SYSTEM SETTING:  
▶CALIBRAITON:ON

This menu configures the XTREME-1000E to set the calibration process.

Calibration	Description
ON	Turns on calibration process
OFF	Turns off calibration process



21540 Prairie St., Unit B - Chatsworth, CA 91311

Phone (818) 773-0333 Fax (818) 773-8330

[www.ktechtelecom.com](http://www.ktechtelecom.com)

### 5.2.14 Preload

SYSTEM SETTING:  
▶PRELOAD:OFF

This menu configures the XTREME-1000E to set the preload option. If preload option is on, the unit will load the last saved predistortion linear and nonlinear data on the next reboot.

<b>Preload</b>	<b>Description</b>
ON	Turns on preload on reboot
OFF	Turns off preload on reboot

### 5.2.15 Menu Lock

SYSTEM SETTING:  
▶MENU LOCK: DISABLE

This menu configures the XTREME-1000E to set the menu lock option. If menu lock option is disable, all of the menu settings can be changed via UP/DOWN keys. If menu lock option is enable, only menu lock setting can be changed via UP/DOWN keys.

<b>Menu Lock</b>	<b>Description</b>
DISABLE	Menu setting can be changed via UP/DOWN keys
ENABLE	Menu setting can NOT be changed via UP/DOWN keys



### **5.3 Status Menus**

The Status menus include:

- RX Power Level
- Source SNR
- Source MPEG2
- PLL
- Serial Number
- Hardware Version
- Software Version
- Error
- Company Display

#### **5.3.1 RX Power Level**

RX STATUS :  
▶RX PWR LEVEL :-

This menu displays the measured feedback power in dBm.

#### **5.3.2 Source SNR**

SOURCE STATUS :  
▶SNR : 29.1dB

This menu displays the input source SNR for 8-VSB RF input

#### **5.3.3 Source MPEG2**

SOURCE STATUS :  
▶MPEG2 : GOOD

This menu displays the MPEG2 status for the selected input

<b>MPEG2</b>	<b>Description</b>
GOOD	MPEG2 sync is detected without errors
BAD	MPEG2 sync is not detected

#### **5.3.4 PLL**

SYSTEM STATUS :  
▶PLL : LOCK

This menu displays the PLL lock condition.

<b>PLL</b>	<b>Description</b>
LOCK	PLL detects lock between the 10 MHz clock and system clock
UNLOCK	PLL detects unlock between the 10 MHz clock and system clock



21540 Prairie St., Unit B - Chatsworth, CA 91311

Phone (818) 773-0333 Fax (818) 773-8330

[www.ktechtelecom.com](http://www.ktechtelecom.com)

### **5.3.5 Serial Number**

```
SYSTEM STATUS:  
▶S/N: abcdef01
```

This menu displays the serial number of the unit. This number must match with the software file when upgrading unit.

### **5.3.6 Hardware Version**

```
SYSTEM STATUS:  
▶HW VERSION:2.3.3
```

This menu displays the hardware file version of the unit.

### **5.3.7 Software Version**

```
SYSTEM STATUS:  
▶SW VERSION:1.7.4
```

This menu displays the software file version of the unit.



21540 Prairie St., Unit B - Chatsworth, CA 91311

Phone (818) 773-0333 Fax (818) 773-8330

[www.ktechtelecom.com](http://www.ktechtelecom.com)

### **5.3.8 Error**

ERROR (UP/DN TO  
CLEAR)

This menu displays the errors of the unit.

<b>ERROR</b>	<b>Description</b>
NONE	No errors
LIN 2A CAPT TIMEOUT	Feedback capture time out when linear precorrection is ON
NLIN 8A CAPT TIMEOUT	Feedback capture time out when nonlinear precorrection is ON
NLIN 8A SNR CALC ERROR	Feedback SNR calculate error when nonlinear precorrection is ON
NLIN 8A REF CALC ERROR	Reference calculate error when nonlinear precorrection is ON
NLIN 8A CALC TIMEOUT	Nonlinear precorrection time out when it is ON
NLIN 8A TX CAPT TIMEOUT	TX capture time out when nonlinear precorrection is ON
MAIN CAPT TIMEOUT	Feedback capture time out after precorrection
NLIN MN CAPTURE TIMEOUT	Feedback capture time out when nonlinear precorrection is on AUTO mode
NLIN MN SNR CALC ERROR	Feedback SNR calculate error when nonlinear precorrection is on AUTO mode
NLIN MN REF CALC ERROR	Reference calculate error when nonlinear precorrection is on AUTO mode
NLIN MN CALC TIMEOUT	Nonlinear precorrection time out when nonlinear precorrection is on AUTO mode
NLIN MN TX CAPT TIMEOUT	TX capture time out when nonlinear precorrection is on AUTO mode
LIN MN TX CAPT TIMEOUT	TX capture time out when linear precorrection is on AUTO mode

### **5.3.9 Company Display**

XTREME-1000E  
(C) KTECH TELECOM 2009

This menu displays company information and unit.



21540 Prairie St., Unit B - Chatsworth, CA 91311

Phone (818) 773-0333 Fax (818) 773-8330

[www.ktechtelecom.com](http://www.ktechtelecom.com)



## **5.4 PSIP Menus**

The PSIP menus include:

- PSIP Update
- PSIP Memory Clear
- PSIP TSID
- PSIP Station ID
- PSIP Virtual Channel
- PSIP Channel TSID

### **5.4.1 PSIP Update**

```
SRC PSIP SETTING
▶UPDATE: ON
```

This menu configures the XTREME-1000E to set PSIP update option. If the update option is ON, the PSIP will be updated automatically. If the update option is OFF, the PSIP will not be updated.

<b>UPDATE</b>	<b>Description</b>
ON	PSIP will be updated
OFF	PSIP will not be updated

### **5.4.2 PSIP Memory Clear**

```
SRC PSIP SETTING
▶MEMORY CLEAR: OFF
```

This menu configures the XTREME to set memory clear option. If the memory clear option is ON, all the PSIP stored in the memory will be set to default ( same as input stream).

<b>MEMORY CLEAR</b>	<b>Description</b>
ON	Clear PSIP stored in memory
OFF	Do not clear PSIP stored in memory

### **5.4.3 PSIP TSID**

```
SRC PSIP TSID
RX: 231   ▶TX: 231
```

This menu configures the XTREME-1000E to set TSID (transport stream ID). RX shows the TSID of input. TX shows the TSID of output. TSID of output can be adjusted via UP/DOWN keys.



21540 Prairie St., Unit B - Chatsworth, CA 91311

Phone (818) 773-0333 Fax (818) 773-8330

[www.ktechtelecom.com](http://www.ktechtelecom.com)

### **5.4.3 PSIP Station ID**

SRC PSIP STID  
(1/3)

This menu configures the XTREME-1000E to set station ID of output. RX shows the station ID of input. TX shows the station ID of output. Station ID of output can be set via keyboard. Use LEFT/RIGHT keys to select character that is to be changed. Use UP/DOWN keys to select desired character.

XTREME-1000E can configure up to three channels. (1/3) indicates that the first channel is being configured currently.

### **5.4.3 PSIP Virtual Channel**

SRC PSIP VCH  
(1/3)

This menu configures the XTREME-1000E to set virtual channel number of currently edited channel. RX shows the virtual channel number of input. TX shows the virtual channel number of currently edited channel. Virtual channel number of currently edited channel can be adjusted via UP/DOWN keys. The format of virtual channel number is major\_channel\_number.minor\_channel\_number.

XTREME-1000E can configure up to three channels. (1/3) indicates that the first channel is being configured currently.

### **5.4.4 PSIP Channel TSID**

SRC PSIP CHTSID  
(1/3)

This menu configures the XTREME-1000E to set channel TSID of currently edited channel. RX shows the channel TSID of input. TX shows the channel TSID of currently edited channel. Channel TSID of currently edited channel can be adjusted via UP/DOWN keys.

XTREME-1000E can configure up to three channels. (1/3) indicates that the first channel is being configured currently.



21540 Prairie St., Unit B - Chatsworth, CA 91311

Phone (818) 773-0333 Fax (818) 773-8330

[www.ktechtelecom.com](http://www.ktechtelecom.com)

## 6. Specifications

### General

Description	Range	Units
<b>AC Power</b>		
Frequency	47-63	Hz
Voltage	90-264	VAC
Current	1.2	Amp (max)
<b>Operating Conditions</b>		
Temperature	-10 ~ +50	°C
Altitude	12,000	ft (max)
Humidity (non-condensing)	95	%
<b>Materials</b>		
Aluminum chassis	0.060" thick AL	
<b>Weight</b>		
Net	25	lbs.
Gross (shipping)	30	lbs.
<b>Dimensions</b>		
Height	3.5	inches (2RU)
Width	19	inches
Depth	18	inches
<b>Cooling</b>		
Blower	Draws air from Front Panel and Exits t the Rear Panel	

### RF Input Specifications

	Specification	Comments
Frequency	50-860 MHz	
USA Channel Numbers	2-69	Frequency Agile
Impedance	75 ohms	
Input RF Power Level	-79dBm ~ -14dBm	Measured over 6MHZ band
Input minimum SNR threshold	15dB	
Connector	BNC	
RF Band	6.0 MHz	

### Demodulator

Parameter	Specification	Comments
Mode	8-VSB Terrestrial	
Equalizer Span	-5.9μS to +40μS	LG 5 <sup>th</sup> Gen Demod
Data Rate	19.392658 Mbps	+/- 54bps
SNR Threshold	15dB	

### SMPTE310M Serial Interface (Baseband Data Input)

Parameter	Specification	Comments
Connector	BNC	
Source Impedance	75 ohms	
Output Coupling	AC	AC inductively coupled
Signal Overshoot	<10%	
Data Format	Biphase Mark Coding	
Transport Stream Bit Rate	19.39265 Mbps	Raw serial data rate ± 2.8 ppm



21540 Prairie St., Unit B - Chatsworth, CA 91311

Phone (818) 773-0333 Fax (818) 773-8330

[www.ktechtelecom.com](http://www.ktechtelecom.com)

**DVB-ASI Serial Interface (Baseband Data Input)**

Parameter	Specification	Comments
Connector	BNC	
Source Impedance	75 ohms	
Output Coupling	AC	AC inductively coupled
Transport Stream Bit Rate (input)	2.6 Mbps Min 19.39265 Mbps Max	
Transport Stream Bit-Rate (output)	19.39265 Mbps	

**PSIP Update**

Parameter	Specification	Comments
Station Identification	Up to seven letters	
Major Channel Number	# 2-69	
Minor Channel Number	# 0-9	

**Modulator**

Parameter	Specification	Comments
Mode	ATSC A53	8-VSB Terrestrial
Symbol Rate	10,762,238 Hz	+/- 30Hz
Linear Correction		
- Group Delay Correction	+/- 500nS max	Max group delay correction
- Typical SNR after correction	34dB	
- Control	Automatic/Manual	On/off selectable
Non-Linear Correction		
- Typical IMD Correction	4dB	
- Typical SNR after correction	34dB	
- Control	Automatic/Manual	On/off selectable
Compliance	ATSC Spec	per ATSC A53 Document

**RF Output**

Description	Specification	Condition
Frequency Range	55-858 MHz	band center
Frequency Channel Selection	Agile – UHF Agile – VHF	UHF VHF
Frequency Stability	<±0.5 ppm	
Aging	<±1 ppm/year	
RF Output Level	0 dBm	
Phase Noise	>-105dBc	At 20 Khz
Impedance	50 ohm	
Connector	SMA	
Spurious	-60 dBc	including harmonics
Return Loss	>18 dB	

**RF Feedback**

Description	Specification	Condition
Frequency Range	55-858 MHz	band center
RF Input Level	0 dBm	+/- 1dB
Impedance	50 ohm	
Connector	SMA-Jack	
Return Loss Required	>18 dB	



21540 Prairie St., Unit B - Chatsworth, CA 91311

Phone (818) 773-0333 Fax (818) 773-8330

[www.ktechtelecom.com](http://www.ktechtelecom.com)

## 7. Typical Performance

The linear precorrection typically improves the SNR to about 28-31dB. Below is the SNR measurement, group delay, and frequency response before linear precorrection.

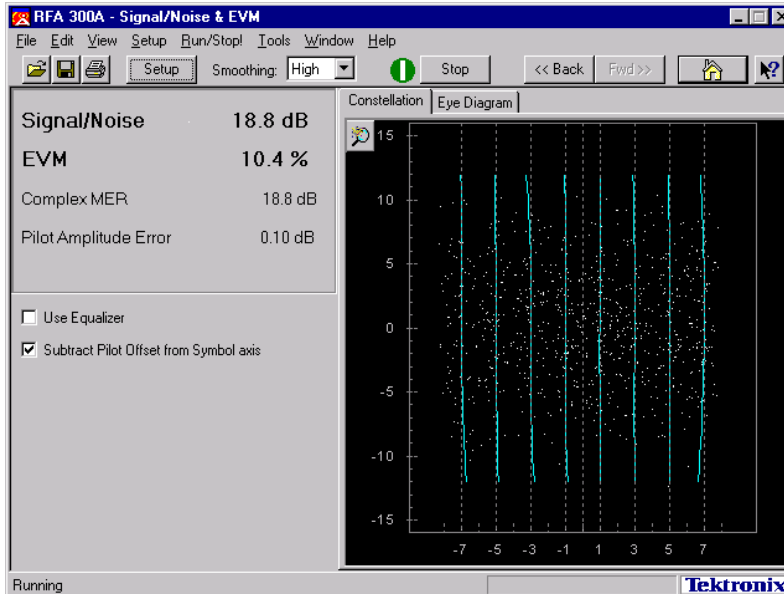

Figure 7.1 SNR measurement before linear precorrection

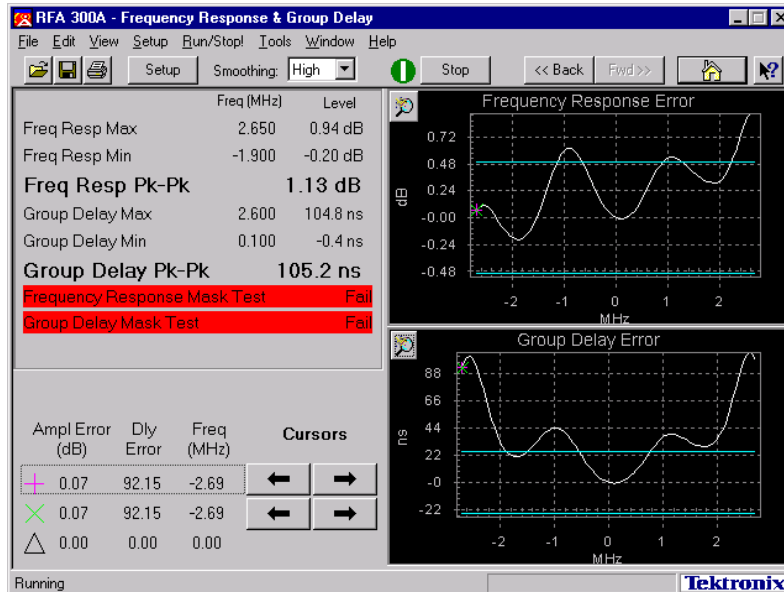

Figure 7.2 Frequency Response and Group Delay before linear precorrection

Below is the SNR measurement, group delay, and frequency response after linear precorrection. The SNR improves to 31dB and meets the FCC requirements. Group delay is reduced to 17.6ns, which is well below the group delay mask test. Frequency response is reduced to 0.40dB which is also well below the frequency response mask test. Performance characteristic is also dependent on the quality of the mask filter.

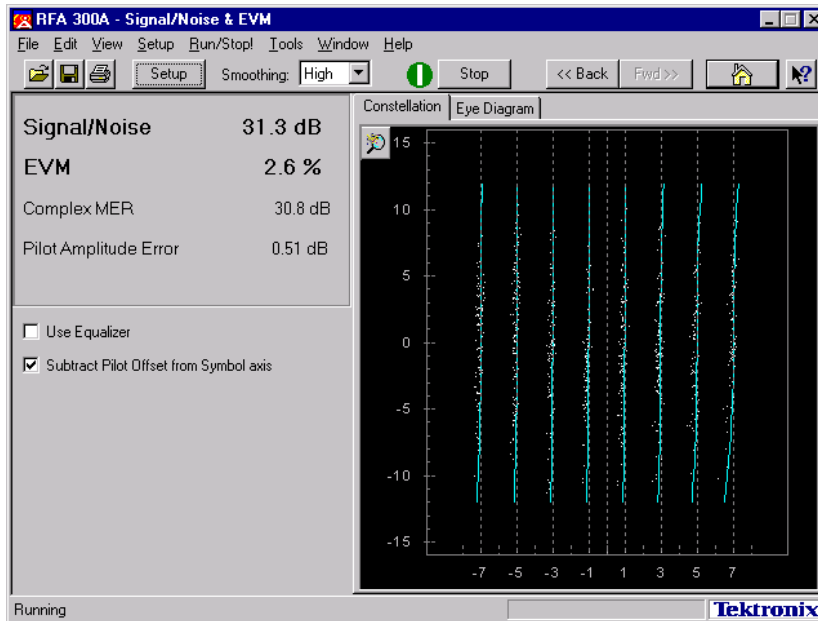

Figure 7.3 SNR measurement after linear precorrection

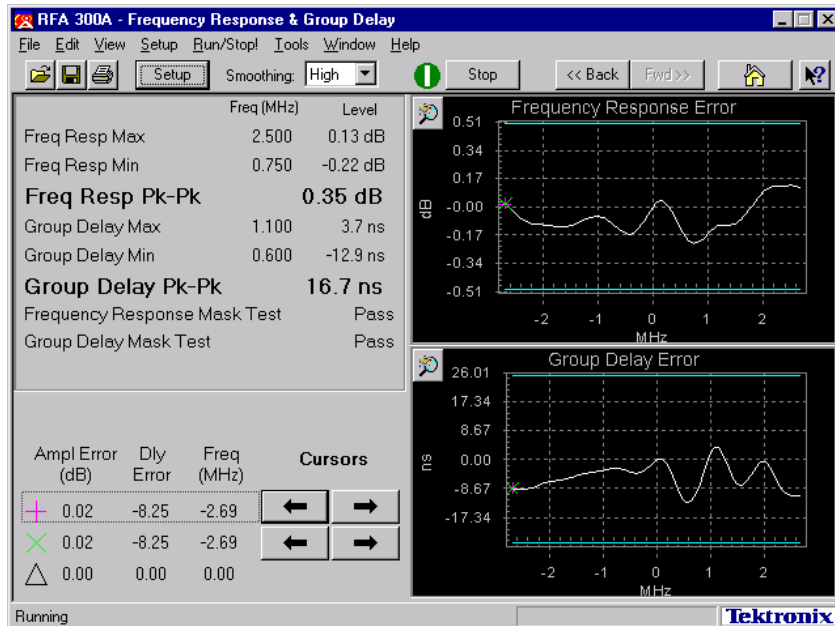

Figure 7.4 Frequency Response and Group Delay after linear precorrection

The nonlinear precorrection typically improves the IMB by 4-5dB. Below is the channel spectrum and out of channel emission measurement before nonlinear precorrection. Also, the top of the spectrum has a flat noise-like appearance after linear and nonlinear precorrection.

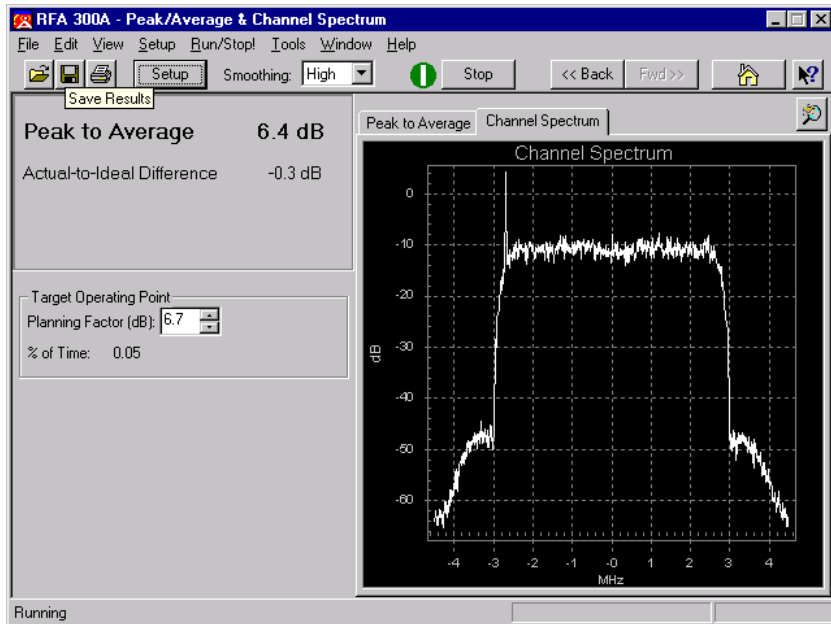

Figure 7.5 Channel Spectrum before nonlinear precorrection

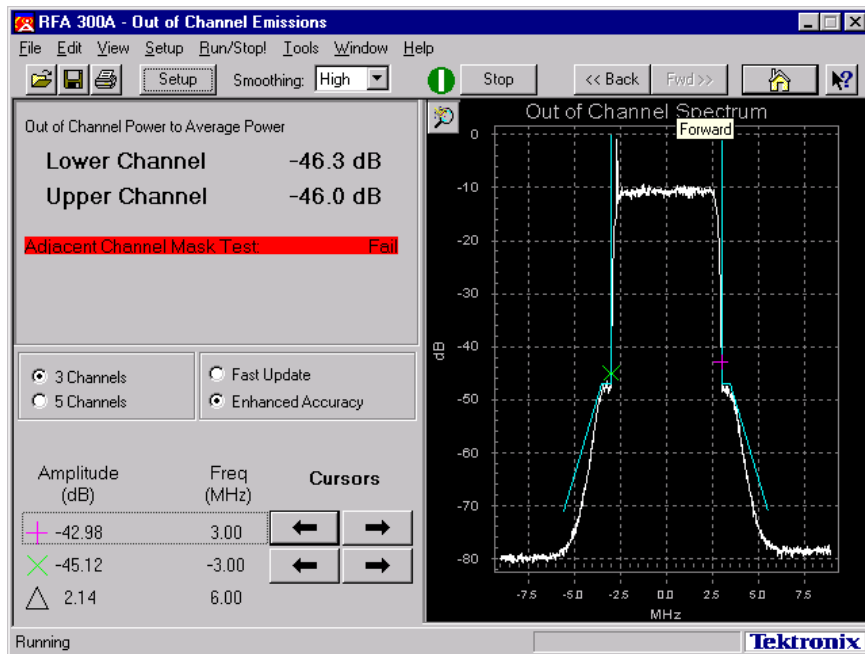

Figure 7.6 Out of Channel Emission before nonlinear precorrection

Below is the channel spectrum and out of channel emission after nonlinear precorrection. The IMB level is improved by 3-4dB. Therefore, the out of channel emission meets the adjacent channel mask test. Typical performance characteristic is also dependent on the quality of the power amplifier stage.

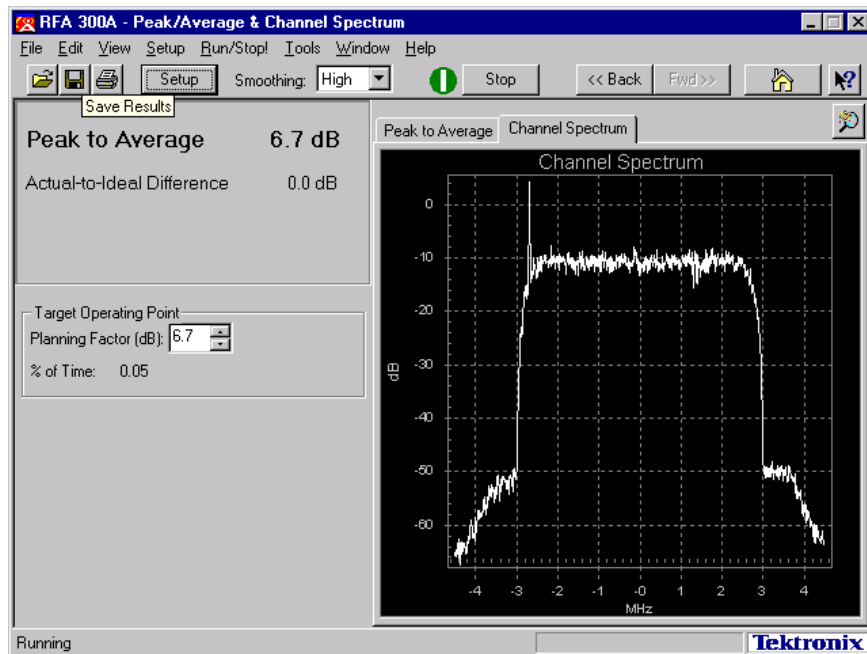

Figure 7.7 Channel Spectrum after nonlinear precorrection

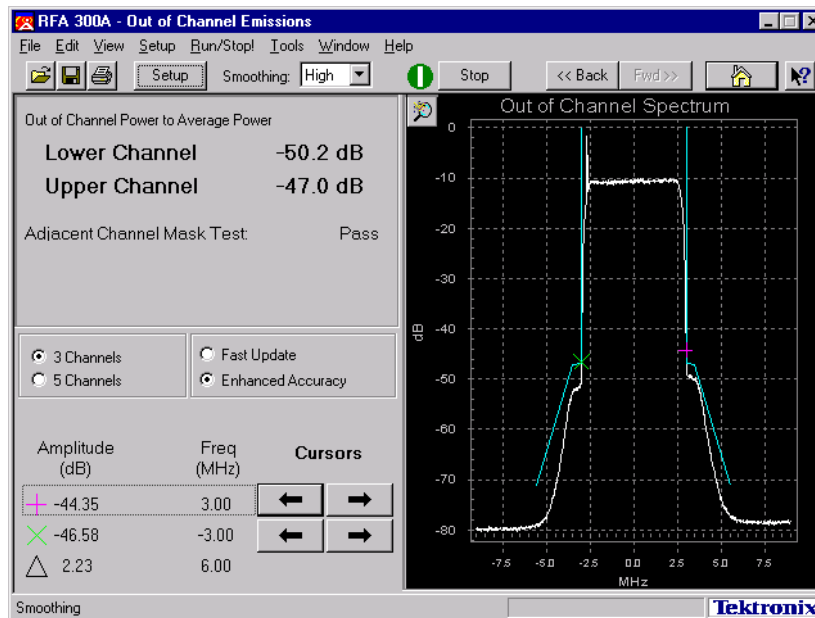

Figure 7.8 Out of Channel Emission after nonlinear precorrection



### Ordering Information

Part Number	Description
XTREME-1000E	8VSB DTV Modulator with automatic linear & non-linear pre-correction. SMPTE-310M input/output standard. - Includes RF demodulator to receive off-air ATSC 8VSB signal

Additional Information at KTech Web Site: [www.ktechtelecom.com](http://www.ktechtelecom.com)

For Pricing and Delivery information: [sales@ktechtelecom.com](mailto:sales@ktechtelecom.com)

**Ktechtelecom**

**DTV Broadcast Products**

21540 Prairie St., Unit B

Chatsworth, CA 91311

Phone (818) 773-0333 Fax (818) 773-8330

**Ktechtelecom**

21540 Prairie St., Unit B - Chatsworth, CA 91311

Phone (818) 773-0333 Fax (818) 773-8330

[www.ktechtelecom.com](http://www.ktechtelecom.com)